



Operator's Manual GASOLINE POWERED CULTIVATOR 43cc, 2 Cycle

MODEL No.S PCV43
PCVR43

For Occasional Use Only

Look inside for:

	Page
Safety Def n t ons	1
Important Safety Informat on	2-3
Product Spec f cat ons	4
Parts & Features	4
Assem y	5-6
Operat on	7-8
Ma ntenance	9
Storage	9
Troub eshoot ng	10
Techn ca Serv ce	10
Warranty	11-16
Span sh	18-33



IMPORTANT:

Thank you for purchasing his Powermate® Cul iva or
Read and unders and all warnings and ins ruc ions in his manual before using his machine mproper use of equipmen
can cause severe injury or dea h Keep his manual for fu ure reference

Record the following for future reference:

Mfg. Date Code : _____

Date of Purchase: Attach a copy of your sales receipt.

Consumer Toll Free Number: 1-800-737-2112

Refer to the website for electronic manual and parts book.
www.powermate.com



If you have a quest on or prob em...









CALL TOLL FREE: 1-800-737-2112

KEEP THIS MANUAL FOR FUTURE REFERENCE





Safety Definitions

• Save all instructions

Safety Warning Symbols:



	Indicates WARNING, DANGER, or CAUTION.		This equipment can throw small objects at high speed causing personal injury. Inspect area where used and remove all foreign objects.
	Read operator's manual before operating this machine. Failure to follow directions could result in serious injury.		Engine exhaust contains carbon monoxide, an odorless and deadly gas. NEVER run unit indoors or in a poorly ventilated area.
	Always wear eye protection that meets or exceeds the requirements of ANSI Z87.1. Wear hearing protection. Wear breathing protection.		To reduce risk of fire, clean spilled gas and oil and keep unit free from debris. Gasoline is extremely flammable. Allow machine to cool completely before refueling.
	Do not use if children or bystanders are present.		Extremely hot surface. Do not touch a hot muffler, gear box or cylinder, you may get burned. These parts get extremely hot from operation and remain hot for a short time after the unit is turned off.
	Keep hands, feet, and clothing away from rotating tines. Contact with rotating tines may result in serious injury.		

Control and Operating Symbols:

	Choke Control: Run/Warm Start Choke/Cold Start		Fuel Mixture: 40:1 (Unleaded Gas : 2 Cycle Oil)
	Fuel Primer: Press 6 times.		Throttle Control: SLOW FAST
	Ignition Switch: ON/RUN OFF/STOP		

Safety Alert Symbols

The information listed below should be read and understood by the operator. We utilize the symbols below to allow the reader to recognize important information about their safety.

 DANGER	Indicates an imminently hazardous situation which, if not avoided, will result in death or serious injury.
 WARNING	Indicates a potentially hazardous situation which, if not avoided, could result in death or serious injury.
 CAUTION	Indicates a potentially hazardous situation which, if not avoided, may result in minor or moderate injury or equipment/property damage

Important Safety Information

• Save all instructions

Before Operating Cultivator

1 **READ AND UNDERSTAND ALL INSTRUCTIONS BEFORE OPERATING CULTIVATOR.** Be thoroughly familiar with the controls and the proper use of the equipment. Know how to stop the unit and disengage the controls quickly.

⚠ WARNING

Read and follow all warnings and safety instructions. Failure to do so can result in serious injury to you or bystanders.

2 Avoid Dangerous Environments

- Do not operate the cultivator while under the influence of alcohol, medications, or drugs.
- Do not operate the cultivator when you are tired.
- Do not use the cultivator if you are mentally or physically unable to operate safely.

3 Inspect the cultivator for damaged parts and make sure all fasteners and guards are in place and secure. Replace any damaged parts.

4 Dress properly when operating the cultivator.

- Always wear heavy long pants, boots, gloves, and a long sleeve shirt.
- Do not wear loose clothing or jewelry that can get caught in the moving parts of the cultivator.
- Always wear gloves and substantial footwear when working outside.
- Always wear protective hair covering to contain long hair.

5 Always wear a face or dust mask if operation is dusty.

6 Always wear eye protection that meets or exceeds the requirements of ANSI Z87.1.

7 Always wear hearing protection which meets or exceeds ANSI standards.

8 Thoroughly inspect the area where the cultivator is to be used and remove all foreign objects.

9 Keep the area of operation clear of all persons, particularly small children and pets.

⚠ WARNING

Your equipment can throw small objects at high speed causing personal injury or property damage.

10 Never allow children to operate the equipment. Never allow adults to operate the equipment without proper instructions.

11 Keep in mind that the operator or user is responsible for accidents or hazards occurring to other people, their property, and themselves.

⚠ WARNING

Engine exhaust from this product contains chemicals known to the State of California to cause cancer or birth defects or other reproductive harm.

While Operating Cultivator

1 Stay alert. Use common sense. Watch what you are doing.

2 Do not operate the cultivator if it is damaged or not securely and fully assembled.

3 Never operate the cultivator without good visibility or light.

4 Never operate the machine without proper guards, plates, or other safety or protective devices in place.

5 Keep all parts of your body away from the rotating lines. Do not put hands or feet near or under the rotating parts.

6 Keep children and pets away.

7 Use only for jobs explained in this manual. Do not use the cultivator for any job except that for which it is intended.

8 Maintain your balance and proper footing at all times. Do not overload the machine capacity by a temporary overload.

9 After striking a foreign object stop the engine, remove the wire from the spark plug, thoroughly inspect the machine for any damage, and repair the damage before resuming and operating the machine.

10 Never leave the machine unattended. Stop the engine when leaving the operating position.

11 Stop the engine before unclogging the lines and when making any repairs, adjustments, and inspections.

12 Be careful when tilling in hard ground. The lines may catch in the ground and propel the cultivator forward if this occurs. Let go of the handles and do not restrain the machine.

13 Use extreme caution when reversing or pulling the machine towards you.

14 Do not force the cultivator. It will do the job better and with less likelihood of a risk of injury than the rate for which it was designed.

⚠ DANGER

Never start or run the unit inside a closed room or building. Breathing exhaust fumes can kill.

16 Exercise extreme caution when operating on or crossing gravel drives, walks, or roads. Stay alert for hidden hazards or traffic.

17 Exercise caution to avoid slipping or falling.

18 If the unit should start to vibrate abnormally stop the engine and check immediately for the cause. Vibration is generally a warning sign of trouble.

19 Never operate the machine at high ransport speeds on hard or slippery surfaces.

20 Start the engine carefully according to instructions and withdraw well away from the lines.

21 Never pick up or carry a machine while the engine is running.

Important Safety Information (Continued)

- Save all instructions

While Operating Cultivator (cont.)

⚠ CAUTION

Prolonged exposure to vibrations through use of gasoline powered hand tools could cause blood vessel or nerve damage in fingers, hands, and joints of people prone to circulation disorders or abnormal swellings. Extensive use in cold weather has been linked to blood vessel damage in otherwise healthy people if symptoms occur such as numbness, pain, loss of strength, change in skin color or texture, or loss of feeling in the fingers, hands, or joints. Discontinue the use of this tool and seek medical attention.

Fuel Safety

- 1 Mix and pour fuel outdoors WHERE THERE ARE NO SPARKS OR FLAMES
- 2 Use a container approved for gasoline
- 3 Do not smoke or allow smoking near fuel or the cultivator
- 4 Avoid spilling fuel or oil. Wipe up all fuel spills
- 5 Move at least 10 feet (3 meters) away from fueling site before starting engine. Do not refuel a hot engine. Do not refuel a running engine.
- 6 Stop engine and allow to cool before removing fuel cap. Remove fuel cap slowly.
- 7 Never store engine with fuel in the tank indoors. Fuel and fuel vapors are highly flammable.
- 8 Replace all fuel tank and container caps securely.

Maintenance & Storage of Cultivator

- 1 Stop the engine and disconnect the spark plug before servicing, cleaning, or performing maintenance on the unit. Never attempt to make any adjustments while the engine is running.
- 2 Maintain cultivator with care. Inspect cultivator periodically. Keep machine, attachments, and accessories in safe working condition. If cultivator is not working properly or damaged, have it repaired by a qualified service center.
- 3 Check for misalignment of moving parts, binding of moving parts, broken parts, and any other condition that may affect its operation. Check shear bolts, engine mounting bolts, and other bolts at frequent intervals for proper tightness to be sure the equipment is in safe working condition.
- 4 Keep guards in place and in working order.
- 5 A guard or other part that is damaged should be properly repaired or replaced by a qualified service center.
- 6 Use only genuine Powermate® replacement parts and accessories. Use of any non Powermate® parts or accessories could lead to injury, damage the unit, and void your warranty.
- 7 Do not remove or modify any parts. Removing or modifying parts could lead to injury, damage the machine, and void the warranty.
- 8 Keep handles dry, clean, and free from oil and grease.
- 9 Allow engine to cool and empty the fuel tank before starting or transporting in vehicle. Use up remaining fuel in the carburetor by starting the engine and letting it run until it stops. If the fuel tank has to be drained, do it outdoors.
- 10 When not in use, store cultivator indoors in a dry location. Store cultivator above the reach of children or in a locked area out of the reach of children.
- 11 Store unit and fuel in area where fuel vapors cannot reach sparks or open flames from water heaters, electric motors, or switches, furnaces, etc.
- 12 Always refer to the operator's manual for important details if the cultivator is to be stored for an extended period.
- 13 Follow manufacturer's recommendations for safe loading, unloading, transport, and storage of machine.

Product Specifications

• Save all instructions

Engine	43 cc 2 cycle Full Crank	2 Cycle Oil Type	2-Cycle Oil that meets or exceeds
Idle Speed	2 800 3 000 RPM		JASO – FC Specifications
Tilling Width	7" 10"	Fuel Mix ure	40:1 (Gasoline: 2-Cycle Oil)
Tilling Depth	Up o 5"	Spark Plug	NHSP LD L6 NGK BM6A
Fuel Tank Capacity	28 oz (840 ml)		CHAMP ON CJ8
Fuel Type	Unleaded Gasoline – 87 Octane or higher	Net Weight	or equivalent 33 lbs (15 kg)

Parts & Features

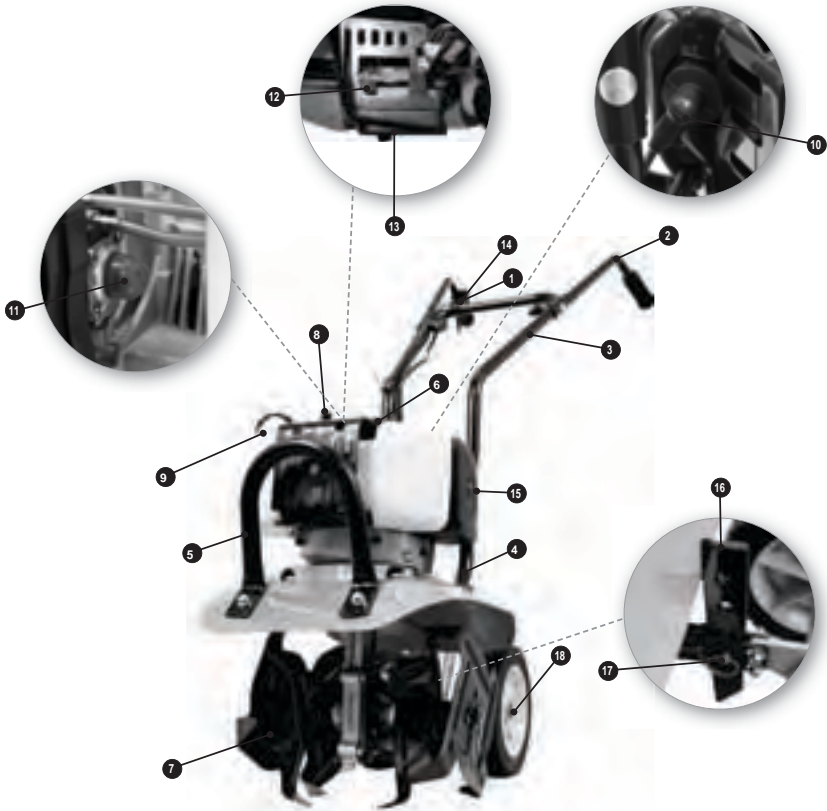

1	Ignition Switch	7	Tines	13	Air Filter Cover
2	Upper Handle	8	Recoil Starter Handle	14	Throttle Trigger
3	Middle Handle	9	Fuel Tank	15	Muffler
4	Lower Handle	10	Spark Plug	16	Drag Stake
5	Front Carry Handle	11	Fuel Primer Bulb	17	Depth Pin
6	Engine	12	Choke	18	Transport Wheels

Assembly

• Save all instructions



If you need assistance or find any parts missing, CALL TOLL FREE: 1-800-737-2112

Parts Included with Cultivator

- Middle Handle (1)
- Upper Handles (2)
- Wing nuts and bolts (4 ea)
- Spark Plug Wrench & Rod (1)
- Cable Ties (3)
- Operator's Manual (1)
- 3.2 oz bottle of 2 Cycle engine oil (1)
- * Wrench (1)

⚠ WARNING

Do not operate cultivator if it is damaged or not securely and fully assembled

How to Unpack Cultivator from Carton

- 1 Remove all parts and packing components
- 2 Use a utility knife to cut all 4 vertical edges. Lay the side panels flat around the cultivator
- 3 Remove inner components and packaging

⚠ CAUTION

Use care when removing parts so do not damage any cables or wires that are attached to the parts

- 4 Roll the unit out from the carton and place on a hard level surface

How to Assemble the Handles and Drag Stake

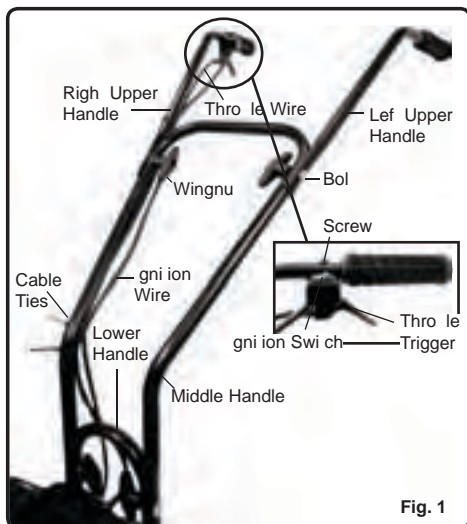

- 1 Place the cultivator upright with the wheels on a hard level surface. Wheels should be set in the lowest position

⚠ WARNING

Do NOT place the cultivator on a high surface where it can fall and cause property damage or personal injury

- 2 Assemble the middle handle to the lower handle with the 2 bolts and wing nuts. Refer to Figure 1. Firmly hand tighten the wing nuts
- 3 Attach the upper handles to the middle handle using the two remaining bolts and wing nuts. Refer to Figure 1
- 4 Assemble the ignition switch and throttle trigger to the right upper handle with the screw. Use included wrench. See Figure 1
- 5 Make sure the ignition wire is connected to both the ignition switch (on the upper handle) and the engine. Make sure the wires are connected at the white connection terminal
- 6 Use the cable ties to secure the throttle cable and ignition wire to the handles
- 7 The drag stake is shipped with the point facing upwards. To use for cultivating, remove the pin and turn the drag stake upside down so the point faces downward. Reinsert the pin. Refer to Figure 2

Assembly (Continued)

• Save all instructions

How to Assemble the Tines

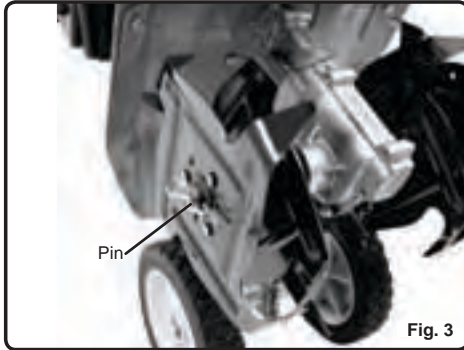

Fig. 3



Fig. 4a

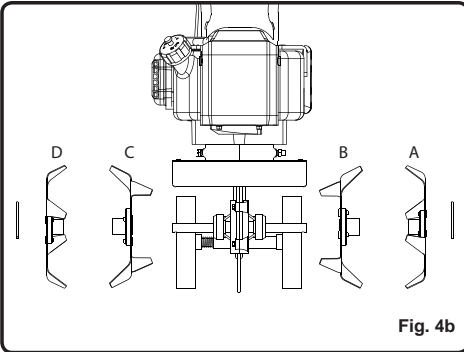

Fig. 4b



Fig. 5

To Remove Tines

- 1 Remove the pins from each end of the tine shaft. Refer to Figure 3.
- 2 Slide the four tines off the tine shaft.

To Install Tines

The 4 different tines are labeled "A" "B" "C" and "D". Refer to Figure 4a for the location of the label.

For a 10" cutting width:

- 1 Assemble the tines as shown in Figure 4b. Make sure the collars of the tines are facing each other.
- 2 Insert the pins into the holes at each end of the tine shaft to lock the tines in place. See Figure 3.

For a 7" cutting width:

- 1 Only assemble tines B and C (the two inside tines). Do not assemble tines A and D (the two outside tines). Refer to Figure 4b.
- 2 Insert the pins into the NS DE holes of the tine shaft to lock the tines in place. See Figure 5.

Operation

• Save all instructions

A Before Starting Engine:

Mixing Fuel / 2-Cycle Oil

WARNING

Do not smoke or allow smoking near fuel or the cultivator or Mix and pour fuel outdoors WHERE THERE ARE NO SPARKS OR FLAMES

The 2 cycle engine on your cultivator requires the fuel and 2 cycle engine oil need to be pre mixed before adding to the fuel tank

WARNING

Always mix the gasoline and 2 cycle oil in a container approved for gasoline. Never mix fuel directly in the engine fuel tank

Use fresh unleaded gasoline with an octane rating of 87 or higher and less than 10% ethanol or methanol

Use 2 cycle oil that meets or exceeds JASO FC specifications and is intended for mixing a fuel to oil ratio of 40:1

CAUTION

Use of incorrect gasoline such as diesel fuel or gasoline containing more than 10% ethanol or methanol will damage the cultivator or engine and void your warranty

CAUTION

Use of incorrect oil such as automotive oil, 2 cycle marine outboard oil, or any oil other than specified oil will damage the cultivator or engine and void your warranty

To mix the fuel and 2 cycle oil follow instructions on 2 cycle oil container for mixing fuel. Mix gasoline and 2 cycle oil at a ratio of 40:1. A mixture with a 40:1 ratio is obtained by mixing 1 gallon (4 liters) of gasoline with 3.2 ounces of oil (95 ml). After adding oil to gasoline, shake container momentarily to ensure proper mixing.

IMPORTANT Mix only enough fuel for your immediate needs. Do not store pre-mixed fuel.

B Adding Fuel to Cultivator:

- 1 Stop engine and allow it to cool before refueling
- 2 Place the cultivator on the ground or on a sturdy bench and wipe away any debris from around the fuel cap
- 3 Remove fuel cap slowly and use a funnel to pour the mixture into the tank and replace the fuel cap
- 4 Avoid spilling fuel or oil. Wipe up all fuel spills
- 5 Move at least 10 feet (3 meters) away from fueling site before starting engine

C Starting Engine:

Starting a Cold Engine

- 1 Place the cultivator on a flat surface
- 2 Move the ignition switch to the "on" position (See Figure 6)
- 3 Move the choke lever to the "cold start" position (See Figure 7)
- 4 Press the primer bulb 6 times (See Figure 8)
- 5 Grab the recoil starter handle with your right hand and support the cultivator with your left hand (See Figure 9)
- 6 Pull the recoil starter handle sharply until the engine starts and runs
- 7 After engine starts and runs for 10-15 seconds, move choke lever to "run/ warm start" position (See Figure 7)

Starting a Warm Engine

- 1 Place the cultivator on a flat surface
- 2 Move the ignition switch to the "on" position (See Figure 6)
- 3 Move the choke lever to the "run/ warm start" position (See Figure 7)
- 4 Grab the recoil starter handle with your right hand and support the cultivator with your left hand (See Figure 9)
- 5 Pull the recoil starter handle sharply until the engine starts and runs

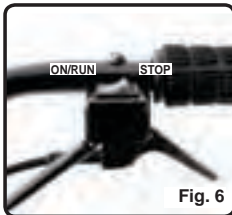

Fig. 6

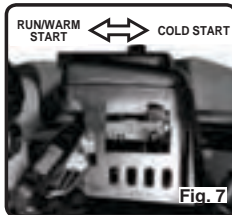

Fig. 7

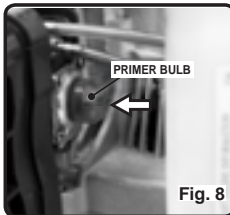

Fig. 8



Fig. 9

Operation (Continued)

• Save all instructions

C Starting Engine (Continued):

Starting a Flooded Engine

- 1 Place the culivator on a flat surface
- 2 Move the ignition switch to the ON position
- 3 Move the choke lever to the 'run/ warm start' position (see Figure 7)
- 4 Hold the throttle trigger fully depressed in fast position (See Figure 10)
- 5 Pull the recoil starter handle repeatedly until the engine starts and runs. This could require pulling the recoil starter handle many times depending on how badly the unit is flooded.
- 6 If the engine still does not start, allow the unit to sit for about 15 minutes and repeat steps 1-5.

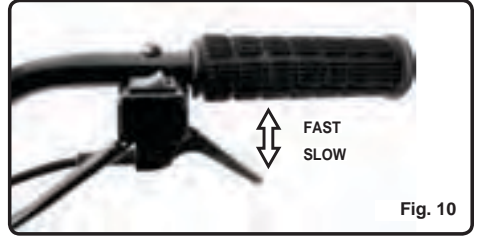

Fig. 10

If the unit still doesn't start, refer to the TROUBLESHOOTING section of this manual or:



If you need assistance or have any questions, CALL TOLL FREE: 1-800-737-2112

D Adjusting Engine Speed:

Not all culivators are equipped with a centrifugal clutch, so the lines will not turn until the engine speed is increased.

To increase the engine speed, lift up on the throttle trigger (See Figure 10).

To slow the engine down, slowly release the throttle trigger. Completely releasing the throttle lever will return the engine to idle and will stop the lines from rotating.

E Stopping the Engine:

- 1 Release the throttle trigger and allow the engine to idle for a few moments (See Figure 10)
- 2 Push and hold the ignition switch to the 'stop' position (See Figure 6)

F Adjusting the Drag Stake Position:

The drag stake adds resistance when culivating which makes the unit easier to control. Also can be adjusted or change the depth of culivating. To adjust the drag stake position, follow the steps below and refer to Figure 11.

- 1 Remove the deen pin
- 2 Slide the stake to the desired position, aligning the hole in the stake with the holes in the support bracket
- 3 Insert the deen pin through the holes to secure the drag stake

Not for the deepest culivating depth, set the drag stake in its lowest position. This will give the greatest resistance and allow for the deepest depth.

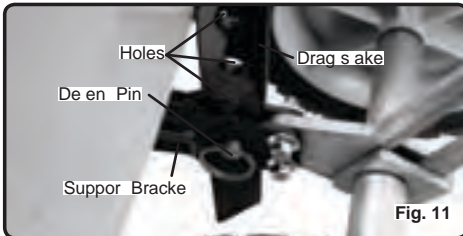

Fig. 11

H Engine Break-In Period:

During the first ten (10) hours of use, use the slowest engine speed which allows for effective cutting and avoid operation at high engine speeds for extended periods of time.

This will maximize the life and performance of your culivator's engine. Maximum power will be achieved after the first ten (10) hours of engine operation.

Maintenance

• Save all instructions

⚠ WARNING

Turn off ignition switch and disconnect the spark plug before performing maintenance except for carburetor adjustments. Reconnect the spark plug wire after the service is done.

A Air Filter

Your cultivator has been equipped with two (2) foam air filters inside the air filter housing to prevent dirt and debris from entering the engine.

Accumulated debris and dust in the air filter will reduce engine performance, increase fuel consumption, and increase the risk of damage. Inspect the air filters frequently for dust and debris build-up and clean the air filters every 5 hours of operation (more frequently in dusty/dirty conditions).

Both air filters should be cleaned by following these instructions:

1. Before removing air filter cover, brush away any loose dirt or debris on and around the filter cover.
2. Remove the screw securing the air filter cover. See Figure 13.
3. Remove and clean foam filter.
 - Light surface dust can readily be removed by tapping the filter.
 - Heavy deposits should be washed out in soap and water. Squeeze out any remaining water and allow the filter to completely dry.



Fig. 13

⚠ WARNING

Never clean filter in gasoline or other flammable solvents.

4. Add a drop of thin oil to the filter and replace it.

B Spark Plug

Inspect the spark plug after every 10-15 hours of use, adjust spark plug gap and replace spark plug as necessary. Replace spark plug every year to maintain engine performance and easy starting.

To inspect or replace the spark plug:

1. Remove the insulated spark plug boot.
2. Use the spark plug wrench to remove the spark plug by turning counter-clockwise.
3. Visually inspect the spark plug for cracks or damage. If damaged, replace spark plug with a recommended replacement (see "Product Specifications").
4. Clean carbon deposits from excessive carbon build-up; replace spark plug.
5. Adjust the spark plug gap to 0.024-0.028 in (0.6-0.7mm).
6. Reinstall the spark plug finger-tight in the cylinder head and then tighten firmly with the spark plug wrench.
7. Reinstall the insulated spark plug boot.

Storage

1. Allow engine to cool and empty the fuel tank before storing or transporting in vehicle. Use up remaining fuel in the carburetor by starting the engine and letting it run until it stops.
2. When not in use, store cultivator indoors in a dry location. Store cultivator above the reach of children or in a locked area out of the reach of children.
3. Store unit and fuel in area where fuel vapors cannot reach sparks or open flames from water heaters, electric motors or switches, furnaces, etc.
4. When preparing the cultivator for storage or when cultivator will not be used for 30 days or more:
 - a. Empty fuel tank and use up remaining fuel in the carburetor or by starting the engine and letting it run until it stops.
 - b. Inspect and clean the cultivator thoroughly.
 - c. Lightly oil all external metal surfaces.
 - d. Remove the spark plug, place a few drops of 2-cycle engine oil in the cylinder. Pull the recoil starter several times to distribute the oil. Replace the spark plug.
 - e. Inspect and clean air filter as required.

Troubleshooting

• Save all instructions

PROBLEM	POSSIBLE CAUSE(S)	SOLUTION(S)
Engine will not start	<ol style="list-style-type: none"> 1 Ignition Switch in the "OFF" position. 2 Engine flooded 3 Fuel Tank empty 4 Spark Plug not firing 5 Fuel not reaching carburetor 6 Carburetor requires adjustment 	<ol style="list-style-type: none"> 1 Move ignition switch to the ON position 2 See Starting a Flooded Engine in OPERATION section 3 Fill tank with correct fuel mixture 4 Replace Spark Plug 5 Check for kinked or split fuel line repair or replace 6 Contact a qualified service center
Engine will not accelerate lacks power or stalls	<ol style="list-style-type: none"> 1 Fuel not reaching carburetor. 2 Air filter dirty 3 Spark plug fouled 4 Carburetor requires adjustment 5 Carbon build up on muffler or leaf screen 6 Compression low 	<ol style="list-style-type: none"> 1 Check for kinked or split fuel line repair or replace 2 Clean air filter 3 Clean or replace spark plug 4 Contact a qualified service center 5 Contact a qualified service center 6 Contact a qualified service center
Engine smokes excessively	<ol style="list-style-type: none"> 1 Fuel mixture incorrect 2 Air filter dirty 3 Carburetor requires adjustment 4 Choke lever in the CHOKE/COLD START position 	<ol style="list-style-type: none"> 1 Empty Fuel Tank and refill with correct fuel mixture 2 Clean or replace air filter 3 Contact a qualified service center 4 Rotate choke lever to the RUN/WARM START position
Engine runs hot	<ol style="list-style-type: none"> 1 Fuel mixture incorrect 2 Spark Plug incorrect 3 Carburetor requires adjustment 4 Carbon build up on muffler or leaf screen 	<ol style="list-style-type: none"> 1 See Mixing Fuel / 2-Cycle Oil in OPERATION section 2 Replace with correct Spark Plug 3 Contact a qualified service center 4 Contact a qualified service center
Engine will not idle properly	<ol style="list-style-type: none"> 1 Carburetor requires adjustment 2 Crankshaft seals worn 3 Compression low 	<ol style="list-style-type: none"> 1 Contact a qualified service center 2 Contact a qualified service center 3 Contact a qualified service center

Technical Service

You may have further questions about assembling, operating or maintaining this cultivator, so you can contact our Technical Service Department at 1-800-737-2112 (English only)

You may also write to:

METL Corporate Office - CORRESPONDENCE ONLY
ATTN: Technical Service – METL
6700 Wildlife Way
Long Grove, IL 60047



**If you need assistance or have any questions,
 CALL TOLL FREE: 1-800-737-2112**

When contacting the Technical Service Department, have ready:

- Your Name
- Your Address
- Your Phone Number

- Model Number of Product
- Date of Purchase (include copy of receipt for written requests)

Warranty

• Save all instructions

A Powermate® CULTIVATOR Limited Warranty

Always specify model number when contacting the factory.

We reserve the right to amend these specifications at any time without notice. The only warranty applicable is our standard written warranty. We make no other warranty, expressed or implied. **MAT Engine Technologies, LLC** warrants this Cultivator and any parts thereof, to be free from defects in material and workmanship for two years (90 days for reconditioned unit) from the date of first purchase from an authorized dealer, provided that the product has been properly maintained and operated in accordance with all applicable instructions. This warranty is extended only to the original retail purchaser. The bill of sales or proof of purchase must be presented at the time a claim is made under this warranty. This warranty does not cover commercial, industrial, or rental usage, nor does it apply to parts that are not in original condition because of normal wear and tear, or parts that fail or become damaged as a result of misuse, accident, lack of proper maintenance, tampering, or alteration. Travel, handling, transportation, and incidental costs associated with warranty repairs are not reimbursable under this warranty and are the responsibility of the owner. To the full extent allowed by the law of the jurisdiction that governs the sale of the product, this express warranty excludes any and all other expressed warranties and limits the duration of any and all implied warranties, including warranties of merchantability and fitness for a particular purpose to two years from the date of first purchase, and **MAT Engine Technologies, LLC's** liability is hereby limited to the purchase price of the product and **MAT Engine Technologies, LLC** shall not be liable for any other damages whatsoever including indirect, incidental, or consequential damages. Some states do not allow limitation of how long an implied warranty lasts or an exclusion or limitation of incidental or consequential damages, so the above limitation of damages may not apply to you. This warranty provides the original purchaser with specific rights.

For information regarding those rights, please consult the applicable state laws.

METL Corporate Office - CORRESPONDENCE ONLY
ATTN: Technical Service – METL
6700 Wildlife Way
Long Grove, IL 60047

B Federal and California Emissions Control Warranty Statement

This **MAT Engine Technologies, LLC (METL)** outdoor power equipment engine complies with the emissions regulations of:

Powermate® Model No.	Regulatory Agency
PCV43 PCVR43	United States Environmental Protection Agency ("U.S. EPA") and State of California

To the extent there is any conflict between this Emissions Control Warranty and the **METL** Limited Warranty, this Emissions Control Warranty shall apply except where the **METL** Limited Warranty may provide a longer warranty period.

YOUR WARRANTY RIGHTS AND OBLIGATIONS

State of California:

The California Air Resources Board and **MAT Engine Technologies, LLC (METL)** are pleased to explain the emissions control system warranty on your 2009 small off road engine (SORE) in California. New SOREs must be designed, built, and equipped to meet the State's stringent air smog standards. **METL** must warrant the emissions control system on your SOREs for the periods of time listed below provided there has been no abuse, neglect, or improper maintenance of your SOREs.

Warranty (Continued)

• Save all instructions

Other U.S. States / Territories:

In other areas of the United States your outdoor power equipment engine must be designed, built and equipped so as to conform at the time of sale to U.S. EPA emissions standards for small off road spark ignition engines at or below 19 kilowatts.

All of the United States:

Your emission control system may include parts such as the carburetor or fuel injection system, fuel lines, the ignition system and catalytic converter. Also included may be hoses, belts, clamps, connectors and other emission related assemblies.

Where a warrantable condition exists, **METL** will repair your small off road engine at no cost to you including diagnosis, parts and labor.

Manufacturer's Warranty Coverage:

The emissions control system is warranted for two years if any emissions related part on your engine is defective, the part will be repaired or replaced by **METL**.

Owner's Warranty Responsibilities:

- As the SORE owner, you are responsible for the performance of the required maintenance listed in your owner's manual. **METL** recommends that you retain all receipts covering maintenance on your SORE, but **METL** can not deny warranty solely for the lack of receipts or for your failure to ensure the performance of all scheduled maintenance.
- As the SORE owner, you should however be aware that **METL** may deny your warranty coverage if your SORE or a part has failed due to abuse, neglect, improper maintenance or unapproved modifications.
- You are responsible for presenting your SORE to a distributor center or service center authorized by **METL** as soon as the problem exists. The warranty repairs should be completed in a reasonable amount of time, not to exceed 30 days.

If you have any questions regarding your warranty coverage, you should contact **METL** customer service:



If you need assistance or have any questions,
CALL TOLL FREE: 1-800-737-2112

Warranty (Continued)

• Save all instructions

Defects Warranty Coverage:

METL warrants to the original purchaser and each subsequent purchaser that the small off road engine (SORE) (1) has been designed, built and equipped so as to conform with all applicable regulations and (2) is free from defects in materials and workmanship that cause the failure of a warranted part to conform with those regulations as may be applicable to the terms and conditions set out below.

(a) The warranty period begins on the date the engine is first purchased. The warranty period is two years.

(b) Subject to certain conditions and exclusions as set out below, the warranty on emissions related parts is as follows:

(1) Any warranted part that is not scheduled for replacement as required herein in your **Operator's Manual** is warranted for the warranty period set out above. If the part fails during the period of warranty coverage, the part will be repaired or replaced by **METL** according to Subsection (4) below. Any such part repaired or replaced under warranty will be warranted for the remainder of the period.

(2) Any warranted part that is scheduled only for regular inspection in your **Operator's Manual** is warranted for the warranty period set out above. Any such part repaired or replaced under warranty will be warranted for the remaining warranty period.

(3) Any warranted part that is scheduled for replacement as required herein in your **Operator's Manual** is warranted for the period of time before the first scheduled replacement date for that part. If the part fails before the first scheduled replacement, the part will be repaired or replaced by **METL** according to Subsection (4) below. Any such part repaired or replaced under warranty will be warranted for the remainder of the period prior to the first scheduled replacement point for the part.

(4) Repair or replacement of any warranted part under the warranty provisions herein must be performed at a warranty station at no charge to the owner.

(5) Notwithstanding the provisions herein, warranty services or repair will be provided at all of our distribution centers that are franchised to service the subject engines.

(6) The engine owner must not be charged for diagnostic labor that leads to the determination that a warranted part is in fact defective, provided that such diagnostic work is performed at a warranty station.

(7) **METL** is liable for damages to other engine components proximately caused by a failure under warranty of any warranted part.

(8) Throughout the engine warranty period set out above, **METL** will maintain a supply of warranted parts sufficient to meet the expected demand for such parts.

(9) Any replacement part may be used in the performance of any warranty maintenance or repairs and must be provided without charge to the owner. Such use will not reduce the warranty obligations of **METL**.

(10) Add-on or modified parts that are not exempted by the Air Resources Board may not be used. The use of any non-exempted add-on or modified parts by the original or subsequent purchaser will be grounds for disallowing a warranty claim. **METL** will not be liable for warranty failures of warranted parts caused by the use of a non-exempted add-on or modified part.

(11) The manufacturer issuing the warranty shall provide any documents that describe the warranty procedures or policies within five working days or requested by the Air Resources Board.

Warranty (Continued)

• Save all instructions

Emission Warranty Parts List:

The repair or replacement of any warranted part otherwise eligible for warranty coverage may be excluded from such warranty coverage if **METL** demonstrates that the engine has been abused, neglected, or improperly maintained and that such abuse, neglect, or improper maintenance was the direct cause of the need for repair or replacement of the part. The notwithstanding any adjustment of a component that has a factory installed and properly operating adjustment limiting device is still eligible for warranty coverage. The following emissions warranty parts list is covered:

(1) Fuel Metering System:

- (a) Gasoline carburetor assembly and its internal components (if so equipped)
- (b) Fuel filter (if so equipped)
- (c) Carburetor gaskets
- (d) Fuel pump (if so equipped)

(2) Air Induction System including:

- (a) Intake pipe/manifold
- (b) Air cleaner

(3) Ignition System including:

- (a) Spark plug
- (b) Ignition module/coil

(4) Catalytic Muffler Assembly (if so equipped) including:

- (a) Muffler gasket
- (b) Exhaust manifold

(5) Crankcase Breather Assembly including:

- (a) Breather connection tube

(6) Miscellaneous items Used in Above Systems including:

- (a) Switches
- (b) Hoses, belts, connectors, and assemblies

Warranty (Continued)

- Save all instructions

C California Evaporative Emission Control Warranty Statement

YOUR WARRANTY RIGHTS AND OBLIGATIONS

The California Air Resources Board and **METL** are pleased to explain the evaporative emission control system's warranty on your 2009 model year small off road engine (SORE) in California. New SOREs must be designed, built, and equipped to meet the Saes ringen and smog standards. **METL** must warrant the evaporative emission control system on your SOREs for the period of time listed below provided there has been no abuse, neglect, or improper maintenance of your SOREs.

Your evaporative emission control system may include parts such as carburetors, fuel tanks, fuel lines, fuel caps, valves, canisters, filters, vapor hoses, clamps, connectors, and other associated components.

Manufacturer's Warranty Coverage:

This evaporative emission control system is warranted for two years. If any evaporative emission related part on your equipment is defective, the part will be repaired or replaced by **METL**.

Owner's Warranty Responsibilities:

- As the SORE owner, you are responsible for performance of the required maintenance listed in your owner's manual. **METL** recommends that you retain all receipts covering maintenance on your SOREs, but **METL** can not deny warranty solely for the lack of receipts.
- As the SORE owner, you should however be aware that **METL** may deny you warranty coverage if your SOREs or a part have failed due to abuse, neglect, or improper maintenance or unapproved modifications.
- You are responsible for presenting your SOREs to a distributor center or service center authorized by **METL** as soon as the problem exists. The warranty repairs should be completed in a reasonable amount of time, not to exceed 30 days.

If you have any questions regarding your warranty coverage, you should contact **METL** customer service:



If you need assistance or have any questions,
CALL TOLL FREE: 1-800-737-2112

Warranty (Continued)

• Save all instructions

Defects Warranty Coverage:

- (a) The warranty period begins on the date the engine is purchased
- (b) General Evaporative Emissions Warranty Coverage The engine must be warranted to the ultimate purchaser and any subsequent owner of the evaporative emission control system when installed was
- (1) Designed, built and equipped so as to conform with all applicable regulations and
 - (2) Free from defects in materials and workmanship that causes the failure of a warranted part for a period of two years
- (c) The warranty on evaporative emissions related parts will be interpreted as follows
- (1) Any warranted part that is not scheduled for replacement as required maintenance in the written instructions must be warranted for the warranty period defined in subsection (b) (2). If any such part fails during the period of warranty coverage, it must be repaired or replaced by **METL** issuing the warranty. Any such part repaired or replaced under the warranty must be warranted for a time no less than the remaining warranty period.
 - (2) Any warranted part that is scheduled only for regular inspection in the written instructions must be warranted for the warranty period defined in subsection (b) (2). A statement in such written instructions of the effect of "repair or replace as necessary" will not reduce the period of warranty coverage. Any such part repaired or replaced under warranty must be warranted for a time no less than the remaining warranty period.
 - (3) Any warranted part that is scheduled for replacement as required maintenance in the written instructions must be warranted for the period of time prior to the first scheduled replacement point for that part. If the part fails prior to the first scheduled replacement, the part must be repaired or replaced by **METL**. Any such part repaired or replaced under warranty must be warranted for a time no less than the remainder of the period prior to the first scheduled replacement point for the part.
 - (4) Repair or replacement of any warranted part under the warranty provisions of this article must be performed at no charge to the owner at a warranty station.
 - (5) Notwithstanding the provisions of subsection (4) above, warranty services or repairs must be provided at distribution centers that are franchised to service the subject engines or equipment.
 - (6) The owner must not be charged for diagnostic labor that leads to the determination that a warranted part is in fact defective, provided that such diagnostic work is performed at a warranty station.
 - (7) Throughout the evaporative emission control systems warranty period set out in subsection (b) (2) **METL** issuing the warranty must maintain a supply of warranted parts sufficient to meet the expected demand for such parts.
 - (8) Manufacturer approved replacement parts must be used in the performance of any warranty maintenance or repairs and must be provided without charge to the owner. Such use will not reduce the warranty obligations of the manufacturer issuing the warranty.
 - (9) The use of any add-on or modified parts will be grounds for disallowing a warranty claim made in accordance with this article. The manufacturer issuing the warranty will not be liable under this Article for warranty failures of warranted parts caused by the use of an add-on or modified part.
 - (10) **METL** issuing the warranty shall provide any documents that describe the warranty procedures or policies within five working days of request by the Executive Officer.

Evaporative Emission Warranty Parts List:

- (1) Fuel Tank

